

PRODUCT GUIDE

Fiber-Optic Devices TOSLINK™



s e m i c o n d u c t o r

TOSLINK™ Optical Transmission Devices



External appearances of TOSLINK

TOSLINK™ is a family of data transmission devices that use optical signals instead of electrical signals. Because TOSLINK uses an optical fiber cable as a transmission line, it provides the following benefits, compared to electrical transmission using a twisted-pair or coaxial cable:

- The transmission line (i.e. the optical cable) is not susceptible to electromagnetic interference.
- The optical cable does not radiate any electromagnetic noise.
- The optical cable provides a complete galvanic isolation between equipments.

Comparison of TOSLINK devices and photocouplers

A photocoupler is a semiconductor that consists of a light-emitting device and a light-receiving device molded in one package. It is used to provide electrical isolation between input and output. In contrast, TOSLINK uses separate light-emitting and light-receiving units that are connected through a long optical cable.

Because an optical cable is used as a transmission line, it is possible to transmit signals over long distances while providing a galvanic isolation between the transmitting and receiving ends.

Thus, TOSLINK can be viewed, in a sense, as a long-distance photocoupler.

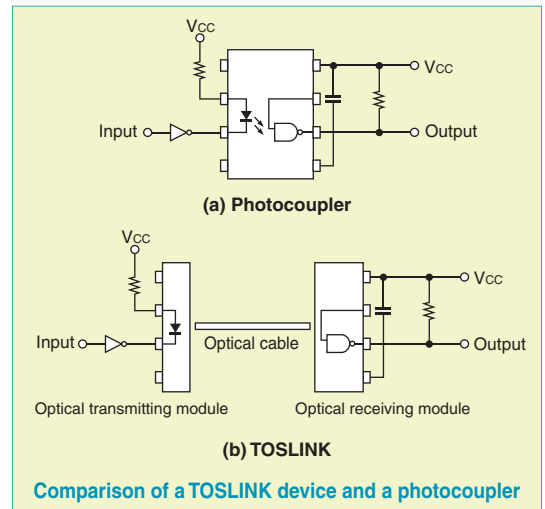

Electrical and optical transmission systems

In an electrical data transmission system, a line driver is used to drive electrical signals through a long transmission line such as a twisted-pair cable. At the other end, a line receiver compensates for signal decay by amplifying the signals. A connector is required at each end of the cable. By contrast, in a TOSLINK-based system, a transmitting module converts electrical signals into optical signals, and a receiving module converts optical signals back to electrical signals. An optical fiber cable is used as a transmission line, and optical connectors link the transmitting and receiving modules to the cable.

The TOSLINK transmitting module incorporates a light-emitting diode and driver circuit. The TOSLINK receiving module incorporates a photodiode and waveform reshaping circuit. The interface is either TTL or PECL for both modules for easy connection with other peripheral ICs.

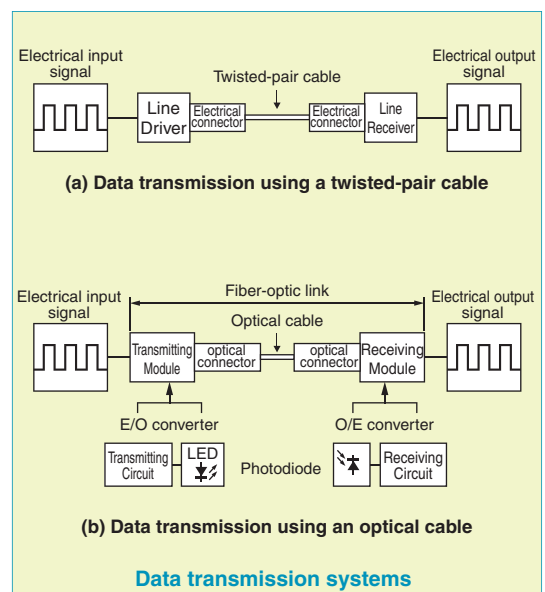

TOSLINK is a trademark of Toshiba Corp.

Optical fiber

An optical fiber consists of a core surrounded by a cladding. An optical ray entering the fiber is reflected back at the boundary between the core and the cladding. In this manner, it travels along the length of the fiber.

There are three kinds of optical fiber:

- a) All-plastic fiber (APF)
- b) Plastic-clad silica fiber (PCF)
- c) Silica fiber

All-plastic fiber, having a plastic core and plastic cladding, is used for short-distance transmission. A plastic-clad silica fiber, which consists of a silica core and plastic cladding, is used for mid-distance transmission. Silica fiber consists of a pure silica core with silica cladding and is used for long-distance transmission. Each optical fiber has a lower transmission loss over a certain wavelength range and is used together with appropriate optical modules.

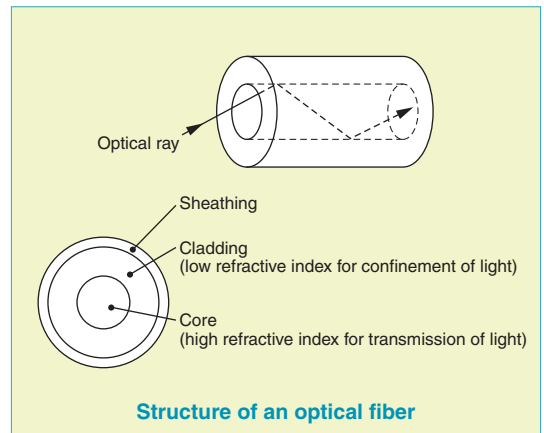

TOSLINK circuit configurations

Optical transmission module

The LED is driven by a differential circuit to reduce current transients generated during the on-off switching of the LED so that the LED's switching does not affect peripheral ICs.

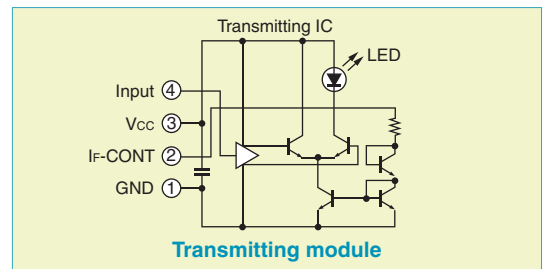

Optical receiving module

The receiving module employs an ATC (automatic threshold control) circuit to reshape the waveform. The ATC circuit controls the comparator reference voltage so that it is always automatically adjusted in accordance with the input optical power. This minimizes pulse width distortion, regardless of the length or bending of the optical fiber.

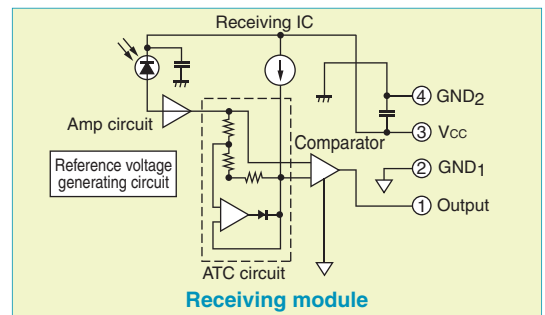

TOSLINK package constructions

There are two package types available for TOSLINK optical modules. One is a molded resin package for ordinary applications. The other is ceramic, used for applications requiring exceptionally high reliability.

The structures of these two packages are shown in the figure on the right. In the molded resin package, devices are mounted on a leadframe and molded with transparent resin. In the ceramic package, devices are mounted on a ceramic substrate and hermetically sealed by a metal shell. The ceramic package provides better resistance against humidity and temperature than the molded resin package.

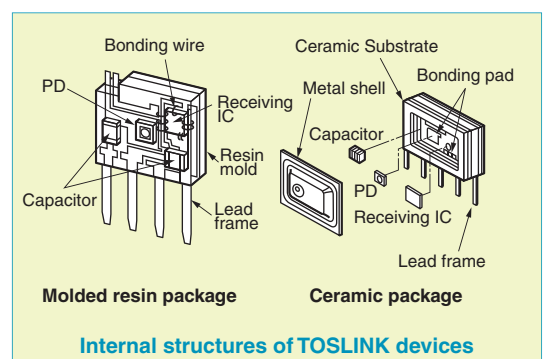

TOSLINK™ Optical Transmission Devices

TOSLINK categories

The Toshiba TOSLINK products are broadly categorized as follows.

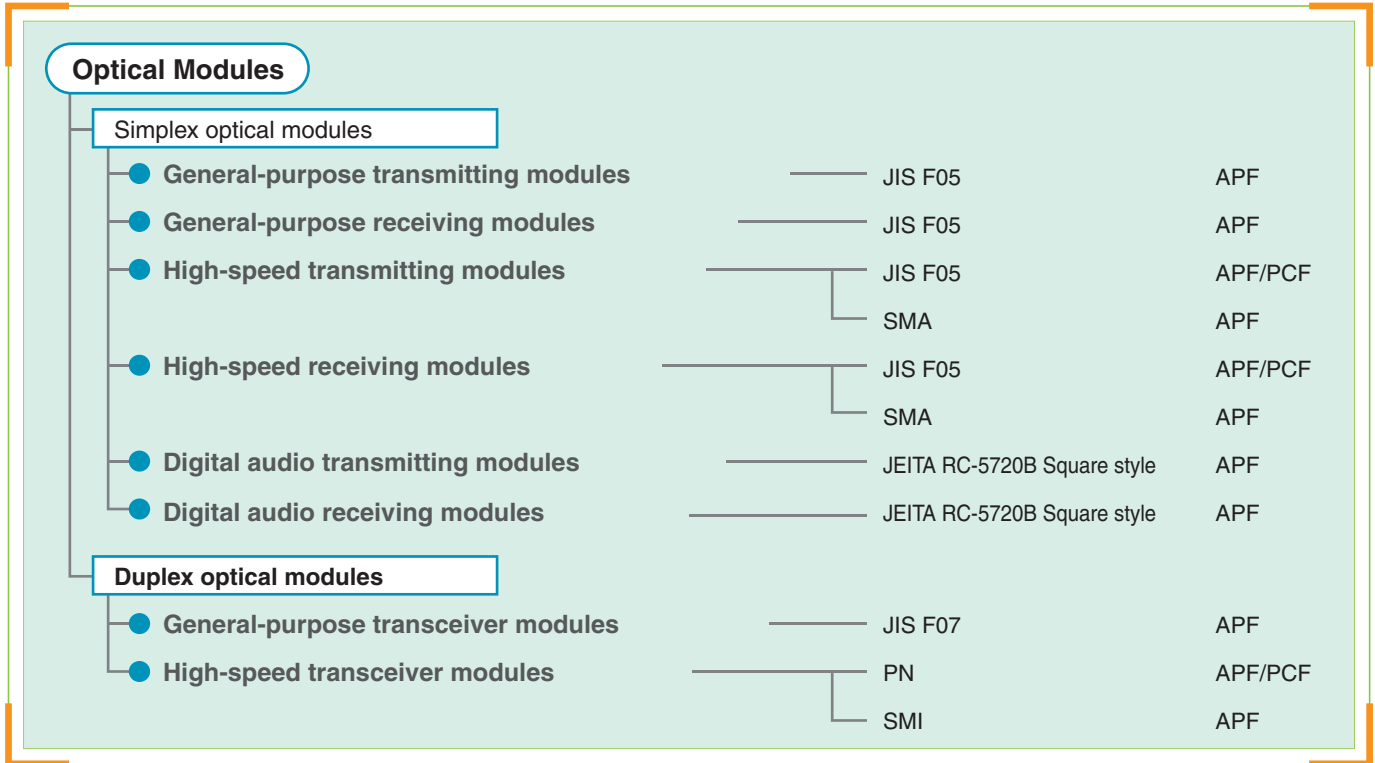

TOSLINK application examples

TOSLINK is used in a wide variety of applications, such as digital audio and factory automation.

Factory automation (FA)

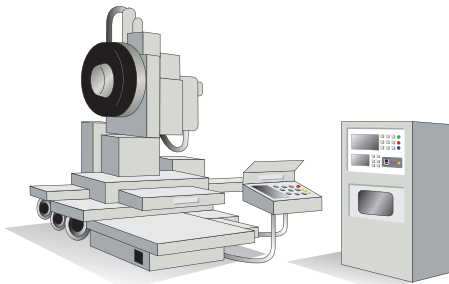

Digital audio

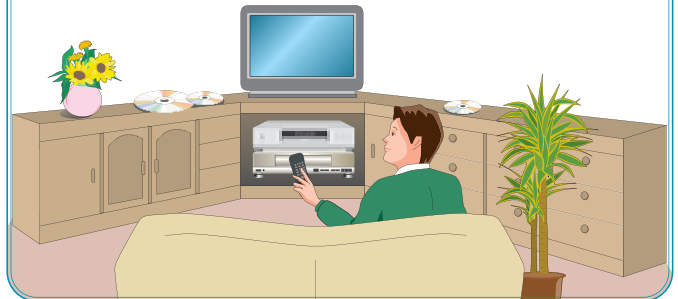

Car audio and navigation systems

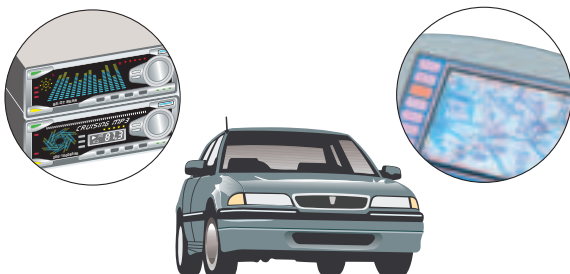

Office automation (OA)



General-Purpose Optical Modules

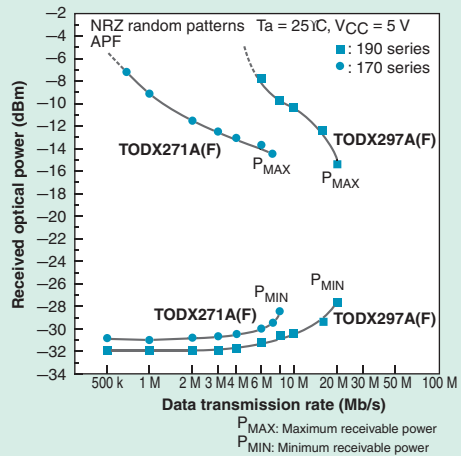

Dynamic ranges of general-purpose TOSLINK modules

Toshiba defines general-purpose optical modules as those having a data rate of up to 6 Mb/s (NRZ) over distances up to 40 m (APF). General-purpose optical modules come in two versions: simplex types compatible with F05 connectors and duplex types compatible with F07 connectors. All general-purpose optical modules are housed in molded resin packages. Whereas the 170 Series requires the external resistor value to be adjusted according to the transmission distance, the 190 Series needs no such adjustment. The figure at right illustrates the dynamic ranges of the 170 and 190 Series. The 190 Series offers a dynamic range more than 6 dB wider than the 170 Series.

Application circuits

Application circuits for the TOTX197A(F) and TORX196(F), a pair of transmitting and receiving modules, are shown in the figure on the right. The TOTX197A(F) transmission module requires an external resistor to supply current to the LED. The TORX196(F) receiving module requires an inductor-capacitor noise filter on the Vcc line. The module case is made of conductive resin to provide a shielding effect against external noise. Pins #5 and #6 must be connected to the system ground. There are also duplex modules in the general-purpose TOSLINK series; their application circuits are generally the same as for simplex modules. All the general-purpose modules have a TTL interface for easy connection with peripheral digital ICs.

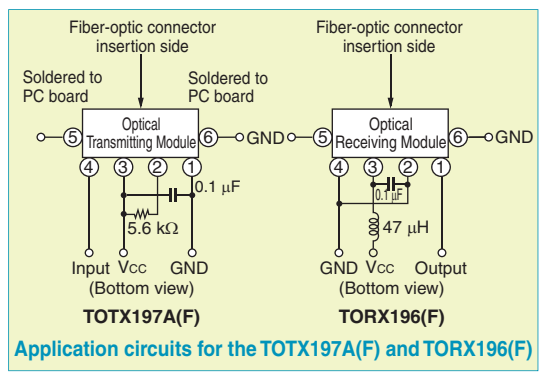

Application circuits for the TOTX197A(F) and TORX196(F)

Receivings modules with an analog output for optical flux monitor—TORX198(F)

Toshiba also offers a general-purpose receiving module with not only a digital output but also an analog output. This receiving module, designated the TORX198(F), provides an analog voltage from the internal amplifier, which changes with the optical power input into the receiving module. Hence, by monitoring the analog output it is possible to measure optical power without dedicated optical power meter. Incorporating such a feature in your system helps to simplify optical power measurements for regular system maintenance. When optical flux monitoring is not required, the TORX198(F) handles digital data transmission like the other TOSLINK receiving modules. In this case, the analog output pin may be left open.

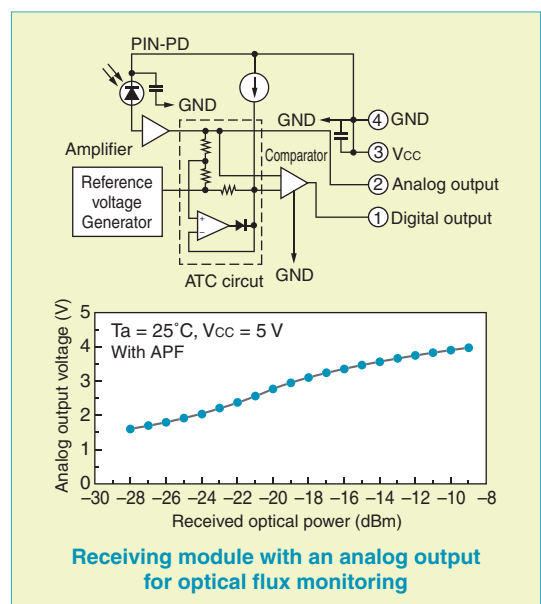

Receiving module with an analog output for optical flux monitoring

Ceramic-Packaged Optical Modules

Toshiba offers several TOSLINK modules housed in ceramic packages that have higher reliability than plastic molded packages. In ceramic packages, devices are mounted on a ceramic substrate and hermetically sealed in metal shells. Ceramic packages provide superior moisture resistance and also reduce the stress put on the internal LED, leading to longer life.

Structure of a ceramic-packaged optical transceiver module

The figure on the right illustrates the structure of the optical transceiver module housed in a ceramic package.

The transmitter section consists of an LED, a transmitting IC that drives the LED, and a chip capacitor mounted on a ceramic substrate.

The receiver section consists of a photodiode, a receiving IC (which contains a waveform-resaping circuit) and chip capacitors mounted on the same ceramic substrate.

Both the transmitter and receiver sections are hermetically sealed in metal shells with glass windows.

The transceiver module is installed in a case to be attached to an optical connector and fastened from the back of the case.

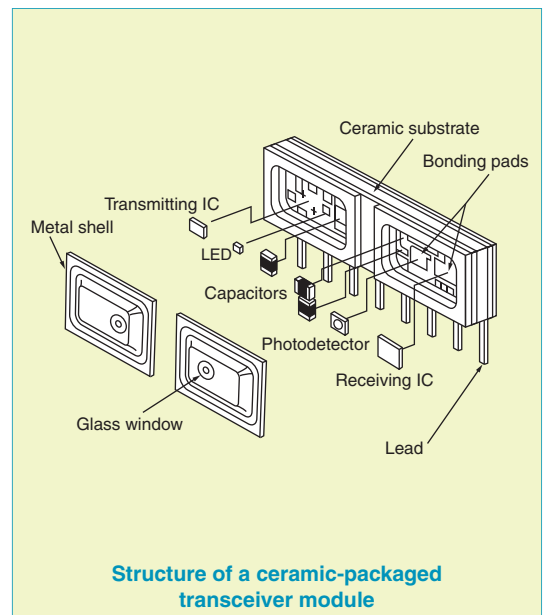

Transceiver module for PN connectors—TODX283(F)

The TODX283(F) transceiver, housed in a ceramic package, can be used with either an APF (all-plastic fiber) or a PCF (plastic-clad silica fiber) cable. Like general-purpose optical modules, the TODX283(F) incorporates a transmitting IC that drives an LED, and a receiving IC containing a waveform-resaping circuit. The interface is TTL, facilitating easy connection with peripheral ICs.

The TODX283(F) is compatible with PN and JIS F7 fiber-optics connectors.

Technical specifications

- ◆ Data rate: DC to 50 Mb/s (NRZ)
- ◆ Transmission distance: up to 10 m (via an APF cable)
up to 100 m (via a PCF cable)
- ◆ Pulse width distortion: less than ± 7 ns
- ◆ Center wavelength: 650 nm
- ◆ Operating temperature: -10°C to 70°C
- ◆ TTL interface



High-Speed Optical Modules

Toshiba offers high-speed optical modules compatible with JIS F05 and SMA connectors for simplex data transmission and those compatible with SMI (Small Multimedia Interface) and PN (Premises Network) connectors for duplex data communication.

JIS F05 and SMA connectors have been widely used in industrial applications.

SMI connectors are suitable for digital home appliances. While SMI connectors are very small, about the same size as digital audio simplex connectors, they provide high-speed, full-duplex data transmission.

PN connectors are an improvement over JIS F07 connectors that have been widely used in industrial applications.

SMI optical transceiver module—TODX2402(F)

The TODX2402(F) optical transceiver module is compatible with SMI connectors that have been proposed as an industry standard for digital home appliance applications.

The TODX2402(F) provides full-duplex 250 Mb/s transmission; thus it supports IEEE 1394 S100 (125 Mb/s), IEEE 1394 S200 (250 Mb/s) and Fast Ethernet (125 Mb/s).

Technical specifications

- ◆ Data rate: 20 to 250 Mb/s (NRZ)
- ◆ Transmission distance: up to 20 m at 250 Mb/s
up to 50 m at 125 Mb/s
- ◆ Center wavelength: 650 nm
- ◆ Operating temperature: 0 to 60°C at 250 Mb/s
-10 to 70°C at 125 Mb/s
- ◆ Built-in transmitting and receiving ICs
- ◆ PECL interface
- ◆ 3.3 ± 0.3 V power supply
- ◆ Mold resin package



TODX2402(F) optical transceiver module

A high-speed AV network can be built by using the TODX2402(F) in combination with an IEEE 1394b PHY layer IC. An example is shown below.

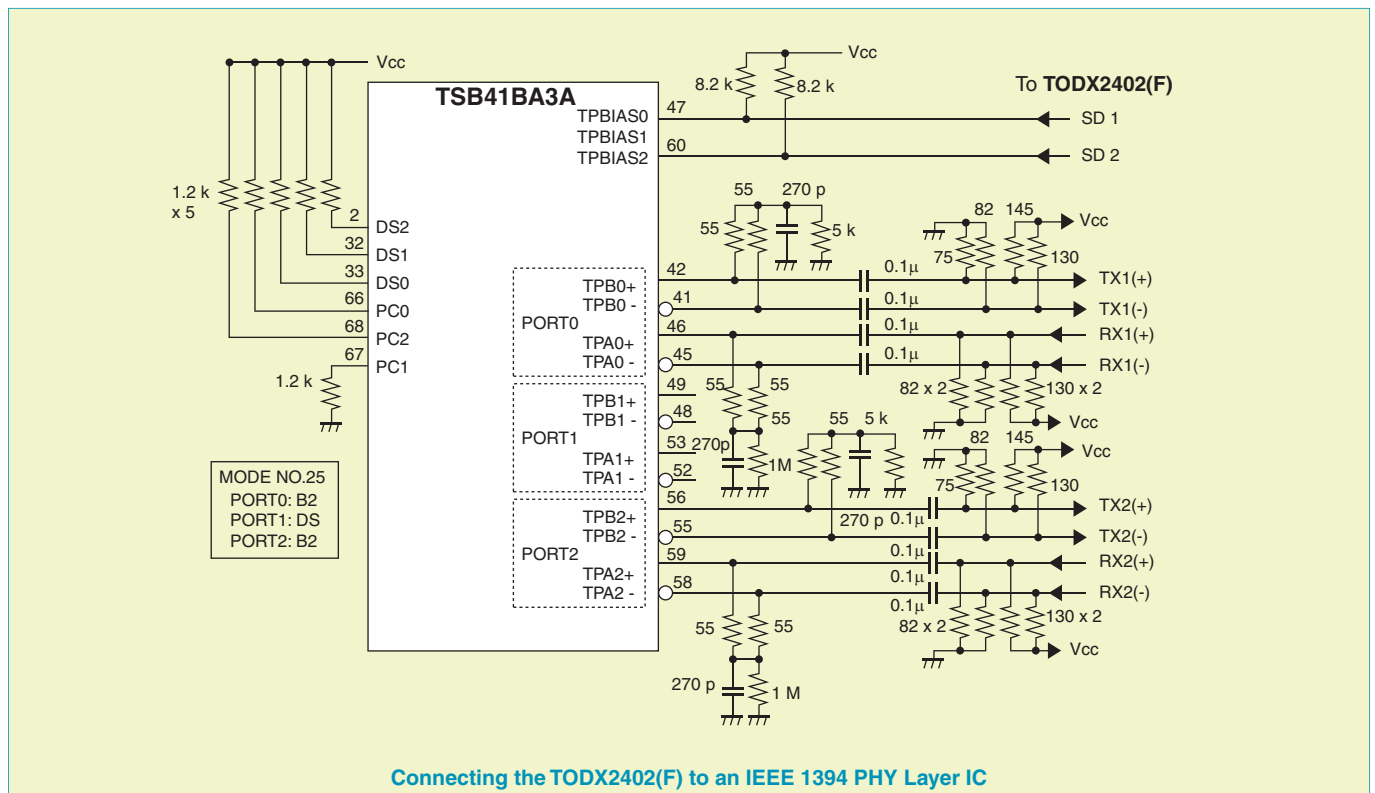

Connecting the TODX2402(F) to an IEEE 1394 PHY Layer IC

Note: The TSB41BA3A is a product of Texas Instruments, Inc. For details on the TSB41BA3A, contact the Product Information Center (PIC) of Texas Instruments, Inc.

PN optical transceiver module—TODX2701(F)

The TODX2701(F) optical transceiver module supports APF (all-plastic fiber) and PCF (plastic-clad silica fiber) cables.

The TODX2701(F) is compatible with PN and JIS07 connectors and well suited for Fast Ethernet (125 Mb/s) transmission.

Technical specifications

- ◆ Data rate: 20 to 125 Mb/s (NRZ)
- ◆ Transmission distance: Up to 20 m of APF
Up to 100 m of GI-PCF
- ◆ Center wavelength: 650 nm
- ◆ Operating temperature: -10 to 70°C
- ◆ PECL interface
- ◆ 3.3 ± 0.3 V power supply



TODX2701(F) optical transceiver module

JIS F05 optical modules—TOTX1701(F) and TORX1701(F)

The TOTX1701(F) optical transmitting module and the TORX1701(F) optical receiving module support APF (all-plastic fiber) and PCF (plastic-clad silica fiber) cables.

They are compatible with JIS F05 connectors and well suited for a high-speed optical ring network.

Technical specifications

- ◆ Data rate: 20 to 125 Mb/s (NRZ code)
- ◆ Transmission distance: Up to 20 m of APF
Up to 100m of GI-PCF
- ◆ Center wavelength: 650 nm
- ◆ Operating temperature: -10 to 70°C
- ◆ PECL interface
- ◆ $3.3 \text{ V} \pm 0.3 \text{ V}$ power supply

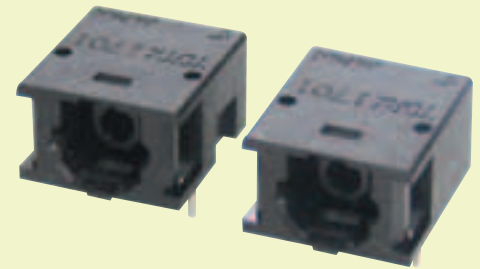

TOTX1701(F)/TORX1701(F) optical modules

SMA optical transmitter and receiver modules—TOTX1400(F) and TORX1400(F)

The TOTX1400(F) optical transmitting module and the TORX1400(F) receiving module support APF (all-plastic fiber) cables.

The TOTX1400(F) and TORX1400(F) are compatible with SMA connectors and well suited for Fast Ethernet (125 Mb/s) transmission.

Technical specifications

- ◆ Data rate: 20 to 125 Mb/s (NRZ)
- ◆ Transmission distance: Up to 50 m of APF
- ◆ Center wavelength: 650 nm
- ◆ Operating temperature: -10 to 70°C
- ◆ PECL interface
- ◆ 3.3 ± 0.3 V power supply

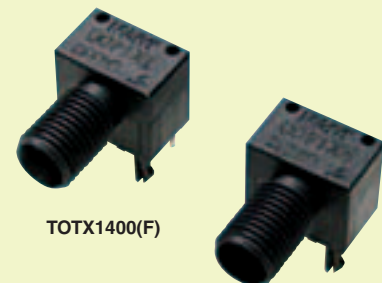



TOTX1400(F)/TORX1400(F) optical modules

Digital Audio Optical Modules

The digital audio optical modules are capable of transferring digital audio interface signals. The interface level and optical connector configuration conform to the Digital Audio Interface (DAI) standards JEITA CP-1212 and RC-5720B respectively. These modules are therefore ideal for a wide variety of applications, ranging from audio visual equipment such as DVD players to sound applications for personal computer and computer entertainment systems.

Product list

Digital audio optical modules are available with an optional shutter and in several choices of packages, supply voltages and data rates.

Package		Power Supply		Data Rate (Mb/s)
		5 V	3 V (3.3 V)	
	Transmitter	TOTX177(F,T) TOTX177(F,TJ)	TOTX147(F,T) TOTX147(F,TJ)	DC to 15
	Receiver	TORX177(F,T) TORX177(F,TJ)	TORX147(F,T) TORX147(F,TJ)	0.1 to 15
	Transmitter	TOTX177L(F,T) TOTX177L(F,TJ)	TOTX147L(F,T) TOTX147L(F,TJ)	DC to 15
	Receiver	TORX177L(F,T) TORX177L(F,TJ)	TORX147L(F,T) TORX147L(F,TJ)	0.1 to 15
	Transmitter	TOTX177PL(F,T) TOTX177PL(F,TJ)	TOTX147PL(F,T) TOTX147PL(F,TJ)	DC to 15
	Receiver	TORX177PL(F,T) TORX177PL(F,TJ)	TORX147PL(F,T) TORX147PL(F,TJ)	0.1 to 15

Optical modules with a wide operating temperature range — TOTX1300(F) and TORX1300(F)

Housed in small packages, the TOTX1300(F) optical transmitting module and the TORX1300(F) optical receiving module feature an operating temperature range of -40°C to 85°C. The TOTX1300(F)/TORX1300(F) pair is an ideal solution for digital audio applications.

Since the TOTX1300(F) and TORX1300(F) support a temperature range wider than general digital audio optical modules, they can be used for car audio systems, etc⁽²⁾.

Technical specifications

- ◆ Storage temperature: -40 to 100°C
- ◆ Operating temperature: -40 to 85°C
- ◆ 5 V ± 0.25 V power supply
- ◆ Pulse width distortion: ±15 ns

TOTX1300(F) Data rate: DC to 15 Mb/s
Fiber output power: -15 to -21 dBm
Center wavelength: 650 nm

TORX1300(F) Data rate: 0.1 to 15 Mb/s
Minimum receivable power: -27 dBm max.

NEW

























Notes: (1) Optical modules with the (F,T) suffix are manufactured by Toshiba Semiconductor Thailand Co., Ltd. The ordering codes for these optical modules have the (F,TJ) suffix in Japan. For details, contact your local Toshiba distributor.

(2) These optical modules are not screened for automotive-level reliability.

Optical Module Product Lines

1. Simplex Optical Modules

1-1. General-purpose optical modules

Transmitting Module	Receiving Module	Data Rate (NRZ, Mb/s)	Wavelength (nm)	Transmission Distance (m) ⁽¹⁾	Pulse Width Distortion (ns) ⁽¹⁾	Power Supply (V)	Operating Temperature (°C)	Compatible Optical Connector	Compatible Optical Fiber (μm)
 TOTX171A(F) ⁽²⁾	 TORX170(F)	DC to 6	650	Up to 40	±55	5 ± 0.25	-40 to 70	JIS F05	APF (980/1000) NA = 0.5
 ★TOTX180B(F) ⁽²⁾⁽³⁾	 TORX180(F) ⁽³⁾	DC to 6	770	Up to 1000	±55	5 ± 0.25	-40 to 85	JIS F05	PCF (200/230)
 ★TOTX180B(F) ⁽²⁾	 TORX186(F) ⁽²⁾	DC to 8	770	Up to 1000	±42	5 ± 0.25	-40 to 85	JIS F05	PCF (200/230)
 ★TOTX181A(F) ⁽²⁾⁽³⁾	 TORX180(F) ⁽²⁾	DC to 6	650	Up to 40	±55	5 ± 0.25	-40 to 85	JIS F05	APF (980/1000) NA = 0.5
 TOTX193A(F)	 TORX193(F)	DC to 6	650	Up to 10	±25	5 ± 0.25	-40 to 85	JIS F05	APF (980/1000) NA = 0.5
 TOTX195A(F) ⁽³⁾	 TORX194(F)	DC to 10	650	Up to 50	±30	5 ± 0.25	-40 to 85	JIS F05	APF (980/1000) NA = 0.5
 TOTX196B(F) ⁽³⁾	 TORX170(F)	DC to 6	770	Up to 1000	±55	5 ± 0.25	-40 to 70	JIS F05	PCF (200/230)
 TOTX196B(F) ⁽³⁾	 TORX194(F)	DC to 10	770	Up to 1000	±30	5 ± 0.25	-40 to 85	JIS F05	PCF (200/230)
 TOTX196B(F)	 TORX196(F)	DC to 6	770	Up to 1000	±55	5 ± 0.25	-40 to 85	JIS F05	PCF (200/230)
 TOTX197A(F)	 TORX196(F)	DC to 6	650	Up to 40	±55	5 ± 0.25	-40 to 85	JIS F05	APF (980/1000) NA = 0.5
 TOTX197A(F)	 TORX198(F) ⁽⁴⁾	DC to 6	650	Up to 40	±55	5 ± 0.25	-40 to 85	JIS F05	APF (980/1000) NA = 0.5





Notes: (1) Ta = 25°C, Vcc = 5 V (2) Ceramic-packaged product

(3) It is necessary to change the external resistor value according to the transmission distance.

(4) Optical receiving module with an analog output terminal for optical flux monitoring.







★: Under development

1-2. High-Speed Optical Modules

Transmitting Module	Receiving Module	Data Rate (NRZ, Mb/s)	Wavelength (nm)	Transmission Distance (m) ⁽¹⁾	Power Supply (V)	Operating Temperature (°C)	Compatible Optical Connector	Compatible Optical Fiber (μm)
 TOTX1400(F)	 TORX1400(F)	20 to 125	650	Up to 50	3.3 ± 0.3	-10 to 70	SMA	APF (980/1000) NA = 0.3
 TOTX1701(F)	 TORX1701(F)	20 to 125	650	Up to 20 (APF) Up to 100 (GI-PCF)	3.3 ± 0.3	-10 to 70	JIS F05	APF (980/1000) NA = 0.5 GI-PCF (200/230)

Notes: (1) Ta = 25°C, Vcc = 5 V

1-3. Digital Audio Transmitting Modules ⁽⁹⁾

Transmitting Module	Data Rate (NRZ, Mb/s)	Wavelength (nm)	Fiber Output Power (dBm) ⁽¹⁾	Pulse Width Distortion (ns) ⁽¹⁾	Power Supply (V)	Operating Temperature (°C)	Compatible Optical Connector	Compatible Optical Fiber (μm)
TOTX147(F,T) ⁽⁵⁾ TOTX147(F,TJ) ⁽⁵⁾ 	DC to 15	650	-21 to -15	±15	2.7 to 3.6	-20 to 70	JEITA RC-5720B Square	APF (980/1000) NA = 0.5
TOTX147L(F,T) ⁽⁵⁾⁽⁶⁾ TOTX147L(F,TJ) ⁽⁵⁾⁽⁶⁾ 	DC to 15	650	-21 to -15	±15	2.7 to 3.6	-20 to 70	JEITA RC-5720B Square	APF (980/1000) NA = 0.5
TOTX147PL(F,T) ⁽⁵⁾⁽⁷⁾ TOTX147PL(F,TJ) ⁽⁵⁾⁽⁷⁾ 	DC to 15	650	-21 to -15	±15	2.7 to 3.6	-20 to 70	JEITA RC-5720B Square	APF (980/1000) NA = 0.5
TOTX177(F,T) ⁽⁵⁾ TOTX177(F,TJ) ⁽⁵⁾ 	DC to 15	650	-21 to -15	±15	5 ± 0.25	-20 to 70	JEITA RC-5720B Square	APF (980/1000) NA = 0.5
TOTX177L(F,T) ⁽⁵⁾⁽⁶⁾ TOTX177L(F,TJ) ⁽⁵⁾⁽⁶⁾ 	DC to 15	650	-21 to -15	±15	5 ± 0.25	-20 to 70	JEITA RC-5720B Square	APF (980/1000) NA = 0.5
TOTX177PL(F,T) ⁽⁵⁾⁽⁷⁾ TOTX177PL(F,TJ) ⁽⁵⁾⁽⁷⁾ 	DC to 15	650	-21 to -15	±15	5 ± 0.25	-20 to 70	JEITA RC-5720B Square	APF (980/1000) NA = 0.5
TOTX1300(F) ⁽⁷⁾⁽⁸⁾ 	DC to 15	650	-21 to -15	±15	5 ± 0.25	-40 to 85	JEITA RC-5720B Square	APF (980/1000) NA = 0.5







Notes: (1) Ta = 25°C, Vcc = 5 V (5) Panel-mount type (6) Shutter-equipped (7) Mini-package type (fixed to printed circuit board)

(8) This optical module is not screened for automotive-level reliability.

(9) Products listed in this table are manufactured by Toshiba Semiconductor Thailand Co., Ltd. For the availability of these products, contact the Toshiba distributors.

Optical modules with the (F,T) suffix are manufactured by Toshiba Semiconductor Thailand Co., Ltd. The ordering codes for these optical modules have the (F,TJ) suffix in Japan. For details, contact the your local Toshiba distributor.

1-4. Digital Audio Receiving Modules ⁽⁹⁾

Receiving Module	Data Rate (NRZ, Mb/s)	Minimum Receivable Power(dBm) ⁽¹⁾	Pulse Width Distortion(ns) ⁽¹⁾	Power Supply (V)	Operating Temperature (°C)	Compatible Optical Connector	Compatible Optical Fiber (μm)
TORX147(F,T) ⁽⁵⁾ TORX147(F,TJ) ⁽⁵⁾ 	0.1 to 15	-24 Max.	±15	2.7 to 3.6	-20 to 70	JEITA RC-5720B Square	APF (980/1000) NA = 0.5
TORX147L(F,T) ⁽⁵⁾⁽⁶⁾ TORX147L(F,TJ) ⁽⁵⁾⁽⁶⁾ 	0.1 to 15	-24 Max.	±15	2.7 to 3.6	-20 to 70	JEITA RC-5720B Square	APF (980/1000) NA = 0.5
TORX147PL(F,T) ⁽⁵⁾⁽⁷⁾ TORX147PL(F,TJ) ⁽⁵⁾⁽⁷⁾ 	0.1 to 15	-24 Max.	±15	2.7 to 3.6	-20 to 70	JEITA RC-5720B Square	APF (980/1000) NA = 0.5
TORX177(F,T) ⁽⁵⁾ TORX177(F,TJ) ⁽⁵⁾ 	0.1 to 15	-24 Max.	±15	5 ± 0.25	-20 to 70	JEITA RC-5720B Square	APF (980/1000) NA = 0.5
TORX177L(F,T) ⁽⁵⁾⁽⁶⁾ TORX177L(F,TJ) ⁽⁵⁾⁽⁶⁾ 	0.1 to 15	-24 Max.	±15	5 ± 0.25	-20 to 70	JEITA RC-5720B Square	APF (980/1000) NA = 0.5
TORX177PL(F,T) ⁽⁵⁾⁽⁷⁾ TORX177PL(F,TJ) ⁽⁵⁾⁽⁷⁾ 	0.1 to 15	-24 Max.	±15	5 ± 0.25	-20 to 70	JEITA RC-5720B Square	APF (980/1000) NA = 0.5
TORX1300 ⁽⁷⁾⁽⁸⁾ 	0.1 to 15	-27 Max.	±15	5 ± 0.25	-40 to 85	JEITA RC-5720B Square	APF (980/1000) NA = 0.5

Notes: (1) Ta = 25°C, Vcc = 5 V (5) Panel-mount type (6) Shutter-equipped (7) Mini-package type (fixed to printed circuit board)





(8) This optical module is not screened for automotive-level reliability.

(9) Products listed in this table are manufactured by Toshiba Semiconductor Thailand Co., Ltd. For the availability of these products, contact the Toshiba distributors.

Optical modules with the (F,T) suffix are manufactured by Toshiba Semiconductor Thailand Co., Ltd. The ordering codes for these optical modules have the (F,TJ) suffix in Japan. For details, contact the your local Toshiba distributor.

2. Duplex Modules

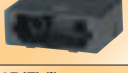
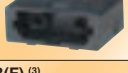
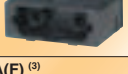
2-1. General-purpose optical modules

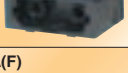
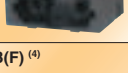
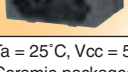
Transceiving Module	Data Rate (NRZ, Mb/s)	Wavelength (nm)	Transmission Distance (m) ⁽¹⁾	Pulse Width Distortion (ns) ⁽¹⁾	Power Supply (V)	Operating Temperature (°C)	Compatible Optical Connector	Compatible Optical Fiber (μm)
 TODX270B(F) ⁽³⁾	DC to 6	770	Up to 1000	±55	5 ± 0.25	-40 to 70	JIS F07	PCF (200/230)
 TODX271A(F) ⁽³⁾	DC to 6	650	Up to 40	±55	5 ± 0.25	-40 to 70	JIS F07	APF (980/1000) NA = 0.5
 ★TODX280B(F) ⁽²⁾⁽³⁾	DC to 6	770	Up to 1000	±55	5 ± 0.25	-40 to 85	JIS F07	PCF (200/230)
 ★TODX281A(F) ⁽²⁾⁽³⁾	DC to 6	650	Up to 40	±55	5 ± 0.25	-40 to 85	JIS F07	APF (980/1000) NA = 0.5
 ★TODX286B(F) ⁽²⁾	DC to 8	770	Up to 1000	±42	5 ± 0.25	-40 to 85	JIS F07	PCF (200/230)
 TODX294B(F) ⁽³⁾	DC to 10	770	Up to 1000	±30	5 ± 0.25	-40 to 85	JIS F07	PCF (200/230)
 TODX295A(F) ⁽³⁾	DC to 10	650	Up to 50	±30	5 ± 0.25	-40 to 85	JIS F07	APF (980/1000) NA = 0.5
 TODX296B(F)	DC to 6	770	Up to 1000	±55	5 ± 0.25	-40 to 85	JIS F07	PCF (200/230)
 TOTX297A(F)	DC to 6	650	Up to 40	±55	5 ± 0.25	-40 to 85	JIS F07	APF (980/1000) NA = 0.5
 TODX298B(F) ⁽⁴⁾	DC to 8	770	Up to 1000	±42	5 ± 0.25	-40 to 85	JIS F07	PCF (200/230)

Notes: (1) Ta = 25°C, Vcc = 5 V



(2) Ceramic-packaged product

(3) It is necessary to change the external resistor value according to the transmission distance.

(4) Optical receiving module with an analog output terminal for optical flux monitoring.

★: Under development

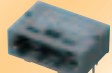
2-2. High-Speed Modules

Transceiving Module	Data Rate (NRZ, Mb/s)	Wavelength (nm)	Transmission Distance (m) ⁽¹⁾	Power Supply (V)	Operating Temperature (°C)	Compatible Optical Connector	Compatible Optical Fiber (μm)
 TODX283(F) ⁽²⁾	DC to 50	650	Up to 10 (APF) Up to 100 (H-PCF)	5 ± 0.25	-10 to 70	PN	APF (980/1000) NA = 0.5 H-PCF (200/230)
 TODX2402(F)	20 to 250	650	Up to 50 (125M) Up to 20 (250M)	3.3 ± 0.3	-10 to 70 (125M) 0 to 60 (250M)	SMI	APF (980/1000) NA = 0.3
 TODX2701(F)	20 to 125	650	Up to 20 (APF) Up to 100 (GI-PCF)	3.3 ± 0.3	-10 to 70	PN	APF (980/1000) NA = 0.5 GI-PCF (200/230)

Notes: (1) Ta = 25°C, Vcc = 5 V

(2) Ceramic-packaged product

Recommended Optical Fibers with Optical Connectors

1. APF

	Category	Product Number	Compatible Optical Connector	Compatible Optical Fiber	Optical Fibers with Optical Connectors			
					Asahi Kasei EMD	Mitsubishi Rayon	Toray Industries	HONDA TSUSHIN
Simplex	General-purpose	TOTX171A(F) TOTX195A(F) TOTX197A(F) TORX170(F) TORX194(F) TORX196(F) TORX198(F) TOTX181A(F) TORX180(F)	JIS F05	APF (980/1000 μm) NA = 0.5	LUCT1-TC1000-***M LUCT1-TC1000-50K-***M LUCT3-TC1000-***M LUCT3-TC1000-50K-***M		TOCP100-***MBT TOCP100P-***MBT TOCP155-***MBT TOCP155P-***MBT	
	High-speed	TOTX1701(F) TORX1701(F)						
	Digital audio	TOTX1400(F) TORX1400(F)	SMA	APF (980/1000 μm) NA = 0.3		RFA3021M-***		
		TOTX177(F,T) TORX177(F,T)	JEITA RC-5720B Square	APF (980/1000 μm) NA = 0.5		RFA4011-***		
Duplex	General-purpose	TODX271A(F) TODX295A(F) TODX297A(F) TODX281A(F)	JIS F07	APF (980/1000 μm) NA = 0.5	LUCT2-TC1000W-***M LUCT2-TC1000W-60K-***M LUCT4-TC1000W-***M LUCT4-TC1000W-60K-***M		TOCP200-***MBT TOCP200P-***MBT TOCP255-***MBT TOCP255P-***MBT	
	High-speed	TODX283(F) TODX2701(F)	PN			RFA4212G-***		
		TODX2402(F)	SMI	APF (980/1000 μm) NA = 0.3		RFA4412M-***		LPG-Z0005P Series

2. PCF

	Category	Product Number	Compatible Optical Connector	Compatible Optical Fiber	Optical Fibers with Optical Connectors	
					Sumitomo Electric Industries	Oki Electric Cable
Simplex	General-purpose	TOTX180B(F), TOTX196B(F) TORX170(F), TORX194(F) TORX196(F), TORX198(F)	JIS F05	H-PCF (200/230 μm)	CF-2071 (HC-20/70) Series	OPC202HV Series
	High-speed	TOTX1701(F), TORX1701(F)	JIS F05	GI-PCF (200/230 μm)	CF-1071 (HG-20/80) Series	
Duplex	General-purpose	TODX270B(F), TODX280B(F), TODX294B(F) TODX296B(F), TODX298B(F)	JIS F07	H-PCF (200/230 μm)	CF-2071 (HC-20/70) Series	OPC202HV Series
	High-speed	TODX283(F)	PN	GI-PCF (200/230 μm)	CF-2071 (HG-20/80) Series	
		TODX2701(F)				

Optical Fibers and Connector Makers List

Optical Fibers Optical Connectors	Asahi Kasei EMD Corporation	TEL +81-3-6911-2740 FAX +81-3-6911-2749
	Oki Electric Cable Co., Ltd.	TEL +81-44-754-4360 FAX +81-44-754-0012
	Sumitomo Electric Industries, Ltd.	TEL +81-3-3423-5031 FAX +81-3-3423-5247
	Toray Industries Inc.	TEL +81-47-350-6058 FAX +81-47-350-6063
	HONDA TSUSHIN KOGYO CO.,LTD.	TEL +81-3-3714-1155 FAX +81-3-5722-7115
	MITSUBISHI RAYON CO., LTD	TEL +81-3-5495-3060 FAX +81-3-5495-3212

Note that the above phone and fax numbers are as of march 2008.

Precautions for Using TOSLINK

1. Reliability

In an optical module that has been in use for some time, nearly all of the deterioration in characteristics is due to a reduction in the fiber-output power (P_f). This is due to deterioration over time in the level of optical output of the LED used as the light source.

The drop in the LED's optical output is thought to be caused by crystal flaws in the wafer or stress in the mold resin, although the detailed causes are not clear.

Although LEDs used for optical communications are generally considered to have an almost infinite lifetime, their optical output does fall over time.

The life of light-emitting devices is greatly affected by the operating conditions and operating environment as well as by the lifespan characteristics of the particular device. Toshiba recommends that the user first check a device's lifetime characteristics before selecting it and setting its operating conditions.

For information on reliability, contact a Toshiba sales office. Regular maintenance, such as a check on the amount of light emitted, is recommended.

2. Soldering

Optical modules use semiconductor devices but are essentially optical components. When soldering, ensure that flux does not adhere to the light-emitting or light-receiving surfaces.

Take the same care when cleaning off flux after soldering.

Some optical modules include a protective cap. This cap is intended to prevent accidental operation when the module is not in use. It is not dust- or waterproof. Because the optical module is an optical component, Toshiba does not recommend soldering methods or post-solder flux cleaning methods in case where flux could affect the module. Toshiba recommends first soldering without mounting the module, then cleaning the PCB. The module should then be hand-soldered and no subsequent cleaning should be performed.

If it is not possible to hand-solder the module, one way of avoiding the effects of flux is to use non-halogen (chlorine-free) flux, taking care not to leave chlorine or other residue, and omitting the post-solder cleaning. In such cases too, the reliability of the device must be checked. Be sure to check the reliability of the device.

3. Noise Resistance

The case for the TOSLINK (simplex) optical receiving module and (duplex) optical transceiver module is made of conductive plastic.

The case is designed to provide shielding against noise when the reinforcing pin at the front of the module is grounded. When the module is used, this pin should be connected to the signal ground.

Since the case for the optical receiving module and optical transceiver module has a resistance of several tens of ohms, ensure that the case does not touch the power line or any other circuits.

Generally, the use of optical transmission devices is considered to improve noise resistance.

While optical fibers are certainly not affected by noise, optical modules, particularly receiver modules, are comparatively easily affected by noise because they handle such minute current signals.

To improve noise resistance, the TOSLINK case is treated to make it conductive. However, since the signal output from the optical receiving modules photodiode is a minute current signal, in some environments simply shielding the case will not protect against noise. When using a TOSLINK device, conduct live tests to check noise resistance.

A simple noise filter is mandatory for the power lines for the TOSLINK optical receiving module and optical transceiver module.

However, in the case of significant power supply ripples, further filter reinforcement is also necessary. In addition, when the optical module is placed in a location susceptible to emission noise, Toshiba recommends covering the optical module and power supply filter with a metal cover to enhance the shielding.

4. Protective Cap

When the optical module is not in use, cover it with the protective cap.

Take particular care with the optical receiving module since, depending on the circuit used, extraneous light may be input to the module when the TOSLINK device is not in use and may adversely affect other circuits.

5. Vibration, Shock and Stress

Plastic-molded optical modules are plastic-sealed devices whose wires are fixed with resin. While this structure makes them comparatively resistant to vibration and shock, wire breakage has been observed in equipment in which the soldering and connections are exposed to vibration, shock or stress. Therefore, when using a plastic-molded optical module in equipment with high vibration levels, ensure that the structure is designed to withstand vibration, shock and stress.

Ceramic-package optical modules are ceramic-sealed, with a hollow interior. Since the wires in the module are not fixed, the module is susceptible to vibration and shock.

Therefore, when using a ceramic-package optical module in equipment which is subject to high levels of vibration and shock, ensure that the structure of the equipment is designed to withstand vibration, shock and stress.

6. Supply Voltage

Modules should be used with a supply voltage within the standard operating conditions. Ensure that the supply voltage does not exceed the absolute maximum ratings even momentarily.

7. Input Voltage

If a voltage exceeding the absolute maximum rating is applied to the transmitter input, the internal IC may be adversely affected or destroyed. If there is a possibility of excessive input voltage due to a surge, for example, add a protective circuit to the input.

8. Output

Note that internal ICs can be damaged when the receiver output is low and the output is shorted to the power supply, or when output is high and is shorted to GND.

9. Handling Optical Fiber Cables

Do not drop heavy or sharp metal objects onto the optical fiber cable. If the fiber cable breaks, data cannot be transmitted.

Also, transmission loss increases with sharp bends in the fiber cable. Toshiba recommends that, if the cable must be bent during installation, the bent section should have as large a radius as possible (six to ten times the minimum bending radius).

Some fiber-optic connectors are vertical connectors. When inserting a fiber-optic connector, note the directionality of the connection. When coupling or decoupling a fiber optic connector, be sure to hold the connector itself. Do not detach a fiber-optic connector by pulling on the optical-fiber cord.

10. Assembling Fiber-Optic Connectors

Since specialized assembly tools are available for the fiber-optic connectors used with TOSLINK devices, people without specialist knowledge can assemble the connectors.

However, the person who assembled the product is responsible for its characteristics and quality.

When a connector is to be used in an application where reliability is essential, Toshiba recommends purchasing a pre-assembled product or contacting a specialist with the necessary expertise.

11. Absolute Maximum Ratings

The absolute maximum ratings must never be exceeded, even momentarily. Even a single rating value must never be exceeded. The nature of the absolute maximum ratings depend on the product but generally include such parameters as the input and output currents, input voltage, storage temperature, operating temperature and lead temperature.

If the input current or voltage exceeds the absolute maximum rating value, overvoltage and overcurrent can adversely affect the internal circuitry of the device. If the rating is grossly exceeded, the wiring may fuse due to heating in the internal circuits, or the circuitry in the semiconductor chips may be destroyed.

If, for example, the absolute maximum operating temperature, storage temperature or soldering temperature rating is exceeded, the differences in the coefficients of thermal expansion of the various materials that make up the device can damage the sealing or open up bonded parts. When using TOSLINK devices, never exceed any of the absolute maximum ratings.

12. Operating Ranges

The operating range is the range of conditions necessary for the device to operate as specified in individual technical datasheets and databooks. Even if a device is operated within the absolute maximum ratings, functional operation of the device or the specifications related to electrical or optical characteristics may not be guaranteed beyond the conditions indicated under "Operating Ranges." Exposure to conditions in excess of these ranges may also affect device reliability. Thus, special precautions are necessary in designing electronic systems. For higher reliability, operating ranges should be derated for current, power and temperature.

13. Smoke and Fire

Since optical modules, connectors and fiber cables are flammable, scorching or burning them may cause them to emit smoke or burst into flame, which can in turn cause gas emissions. Therefore, do not use these devices in the vicinity of flames, smoke or any flammable materials.

14. Disposal Precautions

TOSLINK devices and packaging materials must be disposed of by the user as industrial waste products in an environmentally appropriate way and in accordance with the law.

Toshiba America Electronic Components, Inc.

Headquarters-Irvine, CA
19900 MacArthur Boulevard,
Suite 400, Irvine, CA 92612, U.S.A.
Tel: (949)623-2900 Fax: (949)474-1330

Boulder, CO (Denver)
3100 Araphahoe #500,
Boulder, CO 80303, U.S.A.
Tel: (303)442-3801 Fax: (303)442-7216

Buffalo Grove (Chicago)
2150 E. Lake Cook Road, Suite 310,
Buffalo Grove, IL 60089, U.S.A.
Tel: (847)484-2400 Fax: (847)541-7287

Duluth, GA (Atlanta)
3700 Crestwood Pkwy, #160,
Duluth, GA 30096, U.S.A.
Tel: (770)931-3363 Fax: (770)931-7602

Portland, OR
2560 NW 141st Place Portland,
OR 97229, U.S.A.
Tel: (503)784-8879 Fax: (503)466-9729

Raleigh, NC
3120 Highwoods Blvd., #108, Raleigh,
NC 27604, U.S.A.
Tel: (919)859-2800 Fax: (919)859-2898

Richardson, TX (Dallas)
777 East Campbell Rd., #650, Richardson,
TX 75081, U.S.A.
Tel: (972)480-0470 Fax: (972)235-4114

San Jose Engineering Center, CA
2590 Orchard Parkway San Jose,
CA 95131, U.S.A.
Tel: (408)526-2400 Fax: (408)526-2410

Wakefield, MA (Boston)
401 Edgewater Place, #360, Wakefield,
MA 01880-6229, U.S.A.
Tel: (781)224-0074 Fax: (781)224-1095

Wixom (Detroit)
48679 Alpha Drive, Suite 100, Wixom,
MI 48393 U.S.A.
Tel: (248)449-6165 Fax: (248)449-8430

Toshiba Electronics do Brasil Ltda.
Rua Afonso Celso, 552-8 andar, C.J. 81
Vila Mariana, Cep 04119-002 Sa' o Paulo SP, Brasil
Tel: (011)5576-6619 Fax: (011)5576-6607

Toshiba India Private Ltd.
6F DR. Gopal Das Bhawan 28,
Barakhamba Road, New Delhi, 110001, India
Tel: (011)2331-8422 Fax: (011)2371-4603

Toshiba Electronics Europe GmbH

Düsseldorf Head Office
Hansaallee 181, D-40549 Düsseldorf,
Germany
Tel: (0211)5296-0 Fax: (0211)5296-400

München Office
Büro München Hofmannstrasse 52,
D-81379, München, Germany
Tel: (089)748595-0 Fax: (089)748595-42

France Branch
Les Jardins du Golf 6 rue de Rome F-93561,
Rosny-Sous-Bois, Cedex, France
Tel: (1)48-12-48-12 Fax: (1)48-94-51-15

Italy Branch
Centro Direzionale Colleoni,
Palazzo Perseo 3,
I-20041 Agrate Brianza, (Milan), Italy
Tel: (039)68701 Fax: (039)6870205

Spain Branch
Parque Empresarial, San Fernando, Edificio Europa,
1ª Planta, E-28831 Madrid, Spain
Tel: (91)660-6798 Fax: (91)660-6799

U.K. Branch
Riverside Way, Camberley Surrey,
GU15 3YA, U.K.
Tel: (01276)69-4600 Fax: (01276)69-4800

Sweden Branch
Gustavslundsvägen 18, 5th Floor,
S-167 15 Bromma, Sweden
Tel: (08)704-0900 Fax: (08)80-8459

Toshiba Electronics Asia (Singapore) Pte. Ltd.
438B Alexandra Road, #06-08/12 Alexandra
Technopark, Singapore 119968
Tel: (6278)5252 Fax: (6271)5155

Toshiba Electronics Service (Thailand) Co., Ltd.
135 Moo 5, Bangkadi Industrial Park, Tivanon Road,
Pathumthani, 12000, Thailand
Tel: (02)501-1635 Fax: (02)501-1638

Toshiba Electronics Trading (Malaysia) Sdn. Bhd.

Kuala Lumpur Head Office
Suite W1203, Wisma Consplant, No.2,
Jalan SS 16/4, Subang Jaya, 47500 Petaling Jaya,
Selangor Darul Ehsan, Malaysia
Tel: (03)5631-6311 Fax: (03)5631-6307

Penang Office
Suite 13-1, 13th Floor, Menara Penang Garden,
42-A, Jalan Sultan Ahmad Shah,
10050 Penang, Malaysia
Tel: (04)226-8523 Fax: (04)226-8515

Toshiba Electronics Philippines, Inc.
26th Floor, Citibank Tower, Valero Street, Makati,
Manila, Philippines
Tel: (02)750-5510 Fax: (02)750-5511

Toshiba Electronics Asia, Ltd.

Hong Kong Head Office
Level 11, Tower 2, Grand Century Place, No.193,
Prince Edward Road West, Mongkok, Kowloon, Hong Kong
Tel: 2375-6111 Fax: 2375-0969

Beijing Office
Room 814, Beijing Fortune Building, No.5 Dong San Huan Bei-Lu,
Chao Yang District, Beijing, 100004, China
Tel: (010)6590-8796 Fax: (010)6590-8791

Chengdu Office
Room 2508A, 2 Zongfu Street, Times Plaza,
Chengdu 610016 Sichuan, China
Tel: (028)8675-1773 Fax: (028)8675-1065

Qingdao Office
Room 4(D-E), 24F, International Financial Center,
59 Xiang Gang Zhong Road, Qingdao, Shandong, China
Tel: (0532)579-3328 Fax: (0532)579-3329

Toshiba Electronics Shenzhen Co., Ltd.
28/F, Excellence Times Square Building, 4068 Yi Tian Road,
Fu Tian District, Shenzhen, China
Tel: (0755)2399-6897 Fax: (0755)2399-5573

Toshiba Electronics (Shanghai) Co., Ltd.

Shanghai Head Office
11F, HSBC Tower, 1000 Lujiazui Ring Road,
Pudong New Area, Shanghai 200120, China
Tel: (021)6841-0666 Fax: (021)6841-5002

Hangzhou Office
502 JiaHua International Business Center,
No.28 HangDa Road, Hangzhou, 310007, China
Tel: (0571)8717-5004 Fax: (0571)8717-5013

Nanjing Office
23F Shangmao Century Plaza,
No.49 Zhong Shan South Road, Nanjing, 210005, China
Tel: (025)8689-0070 Fax: (025)8689-0125

Toshiba Electronics (Dalian) Co., Ltd.
14/F, Senmao Building, 147, Zhongshan Road,
Xigang Dist., Dalian, 116011, China
Tel: (0411)8368-6882 Fax: (0411)8369-0822

Tsurong Xiamen Xiangyu Trading Co., Ltd.
14G, International Bank BLDG., No.8 Lujiang Road,
Xiamen, 361001, China
Tel: (0592)226-1398 Fax: (0592)226-1399

Toshiba Electronics Korea Corporation

Seoul Head Office
891, Samsung Life Insurance Daechi Tower 20F, Daechi-dong,
Gangnam-gu, Seoul, 135-738, Korea
Tel: (02)3484-4334 Fax: (02)3484-4302

Gumi Office
6F, Goodmorning Securities Building, 56 Songjung-dong,
Gumi-shi, Gyeongbuk, 730-090, Korea
Tel: (054)456-7613 Fax: (054)456-7617

Toshiba Electronics Taiwan Corporation

Taipei Head Office
10F, No.10, Sec.3, Minsheng E.Rd., Taipei City 10480, Taiwan
Tel: (02)2508-9988 Fax: (02)2508-9999

Kaohsiung Office
16F-A, Chung-Cheng Building, 2, Chung-Cheng 3Road,
Kaohsiung, 80027, Taiwan
Tel: (07)237-0826 Fax: (07)236-0046

The information contained herein is subject to change without notice. 021023_D

TOSHIBA is continually working to improve the quality and reliability of its products. Nevertheless, semiconductor devices in general can malfunction or fail due to their inherent electrical sensitivity and vulnerability to physical stress. It is the responsibility of the buyer, when utilizing TOSHIBA products, to comply with the standards of safety in making a safe design for the entire system, and to avoid situations in which a malfunction or failure of such TOSHIBA products could cause loss of human life, bodily injury or damage to property. In developing your designs, please ensure that TOSHIBA products are used within specified operating ranges as set forth in the most recent TOSHIBA products specifications. Also, please keep in mind the precautions and conditions set forth in the "Handling Guide for Semiconductor Devices," or "TOSHIBA Semiconductor Reliability Handbook" etc. 021023_A

The TOSHIBA products listed in this document are intended for usage in general electronics applications (computer, personal equipment, office equipment, measuring equipment, industrial robotics, domestic appliances, etc.). These TOSHIBA products are neither intended nor warranted for usage in equipment that requires extraordinarily high quality and/or reliability or a malfunction or failure of which may cause loss of human life or bodily injury ("Unintended Usage"). Unintended Usage include atomic energy control instruments, airplane or spaceship instruments, transportation instruments, traffic signal instruments, combustion control instruments, medical instruments, all types of safety devices, etc. Unintended Usage of TOSHIBA products listed in this document shall be made at the customer's own risk. 021023_B

The products described in this document shall not be used or embedded to any downstream products of which manufacture, use and/or sale are prohibited under any applicable laws and regulations. 060106_Q

The information contained herein is presented only as a guide for the applications of our products. No responsibility is assumed by TOSHIBA for any infringements of patents or other rights of the third parties which may result from its use. No license is granted by implication or otherwise under any patents or other rights of TOSHIBA or the third parties. 070122_C

GaAs(Gallium Arsenide) is used in some of the products. The dust or vapor is harmful to the human body. Do not break, cut, crush or dissolve chemically. 021023_J

Please contact your sales representative for product-by-product details in this document regarding RoHS compatibility. Please use these products in this document in compliance with all applicable laws and regulations that regulate the inclusion or use of controlled substances. Toshiba assumes no liability for damage or losses occurring as a result of noncompliance with applicable laws and regulations. 060819_Z

The products described in this document may include products subject to the foreign exchange and foreign trade control laws. 060925_F

TOSHIBA

TOSHIBA CORPORATION
Semiconductor Company

Website: <http://www.semicon.toshiba.co.jp/eng>

©2008 TOSHIBA CORPORATION

Previous edition: BCE0037C
2008-3(0.2k)PC-DQ